

XI August 1887

John W. W. W. W.

TABELLER

TILL

STÅNGJERNS-FÖRSÖKEN

1827.

---

Tab. 1.

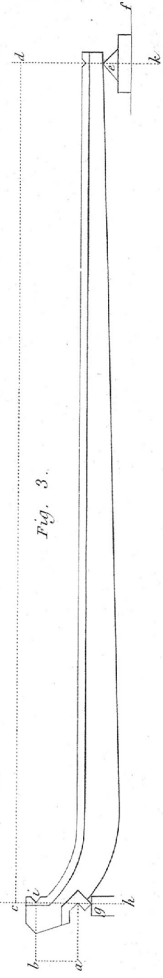

Fig. 3.

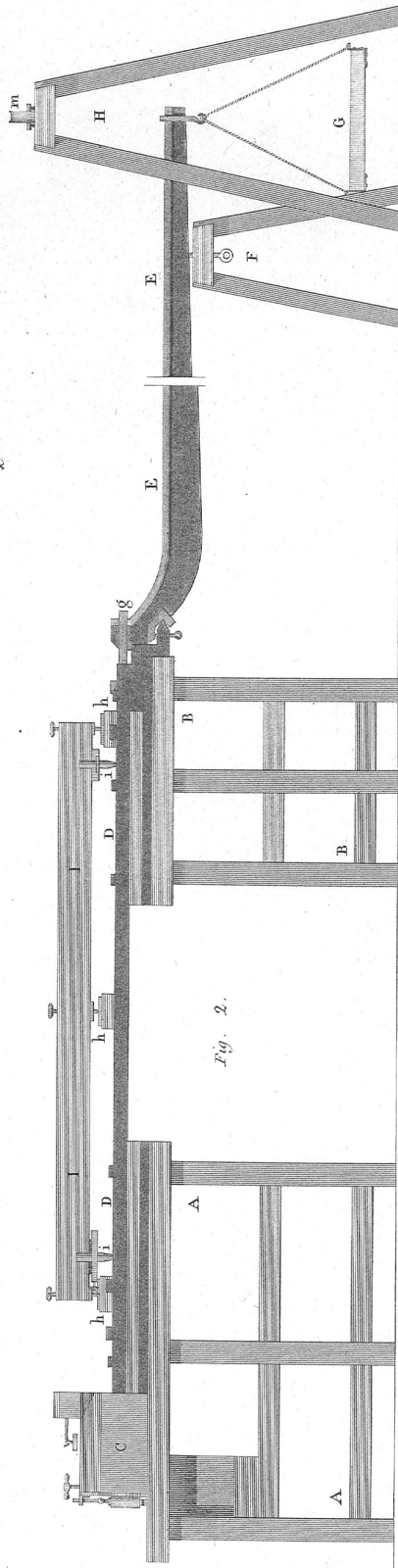

Fig. 2.

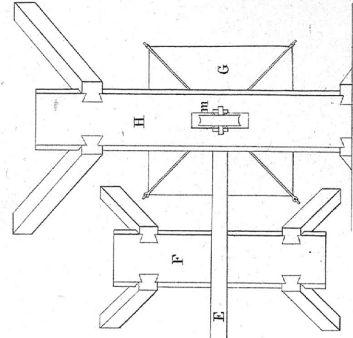
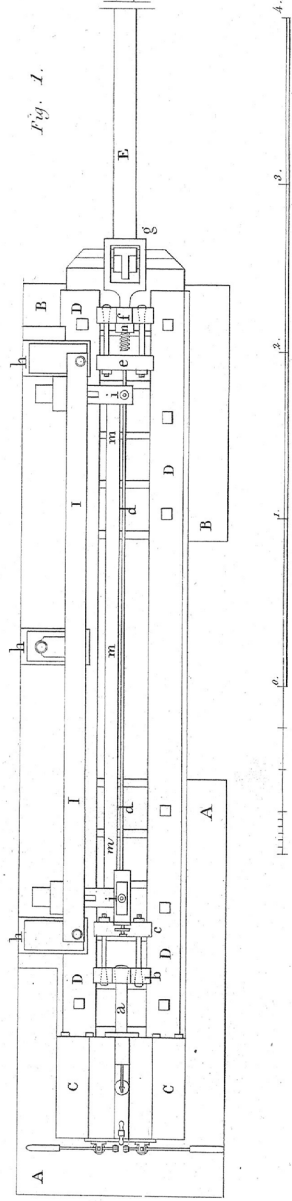

Fig. 1.



1 2 3 4 5 6 7 8 9 10 11 12 13 14 15 16 17 18 19 20 21 22 23 24 25 26 27 28 29 30 31 32 33 34 35 36 37 38 39 40 41 42 43 44 45 46 47 48 49 50 51 52 53 54 55 56 57 58 59 60 61 62 63 64 65 66 67 68 69 70 71 72 73 74 75 76 77 78 79 80 81 82 83 84 85 86 87 88 89 90 91 92 93 94 95 96 97 98 99 100

Aluar.

c. A. 1851. 18. 1

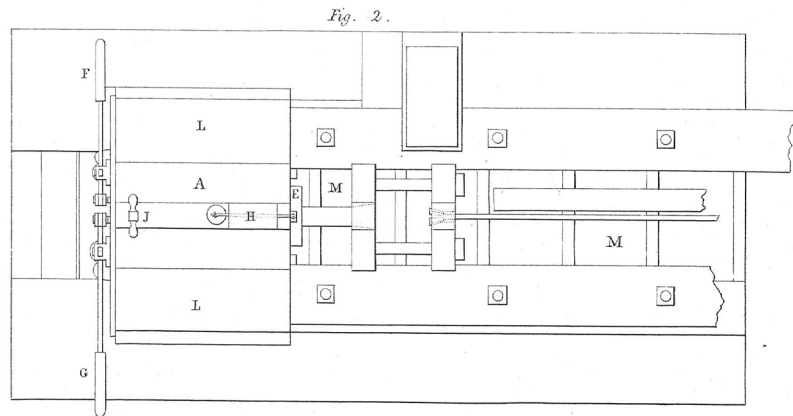
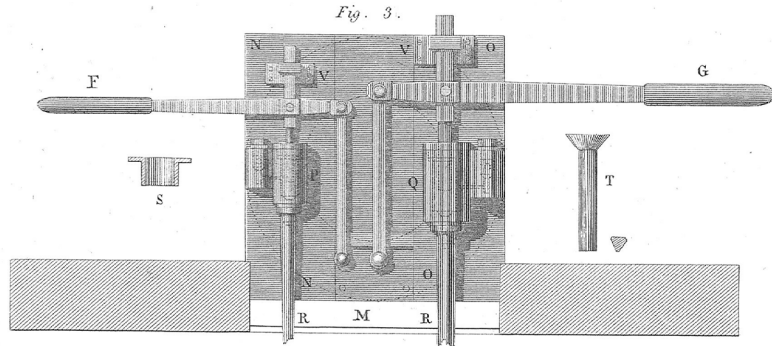
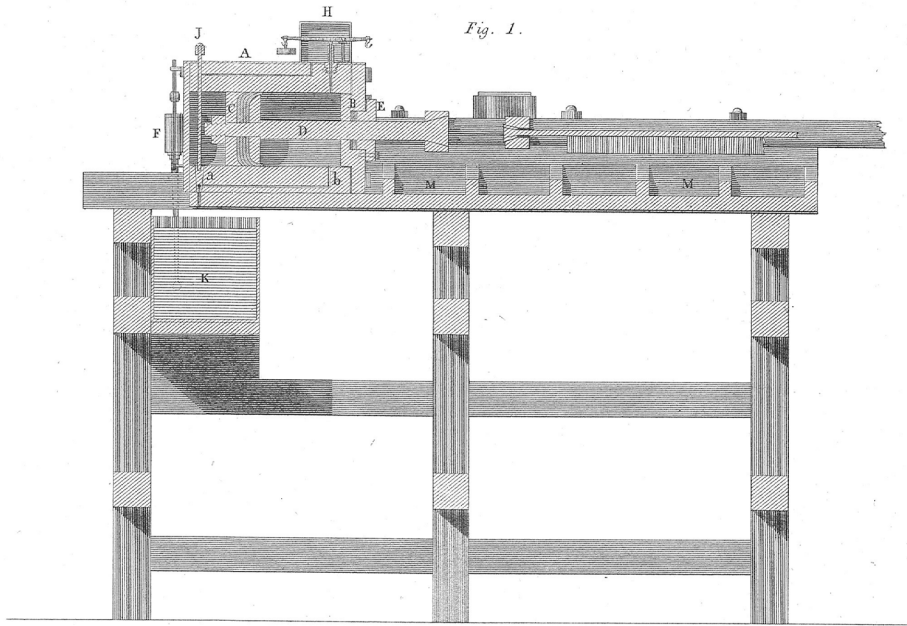

1. 2.  
Aluar.

Tab. III.

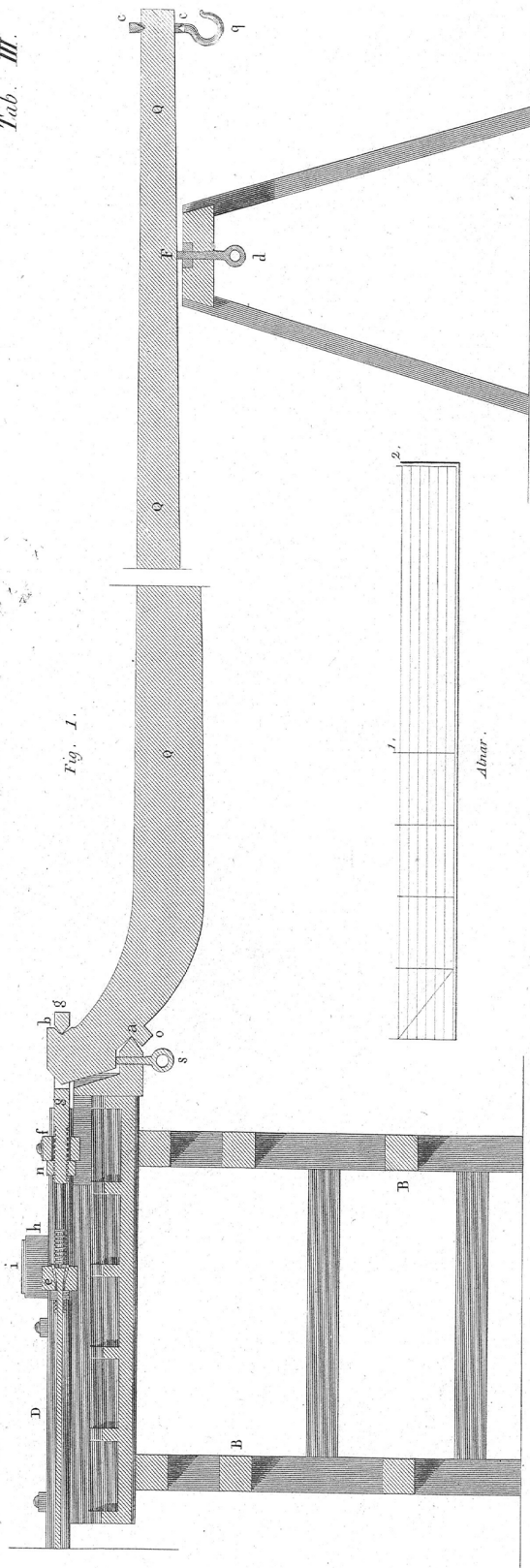

Fig. 1.

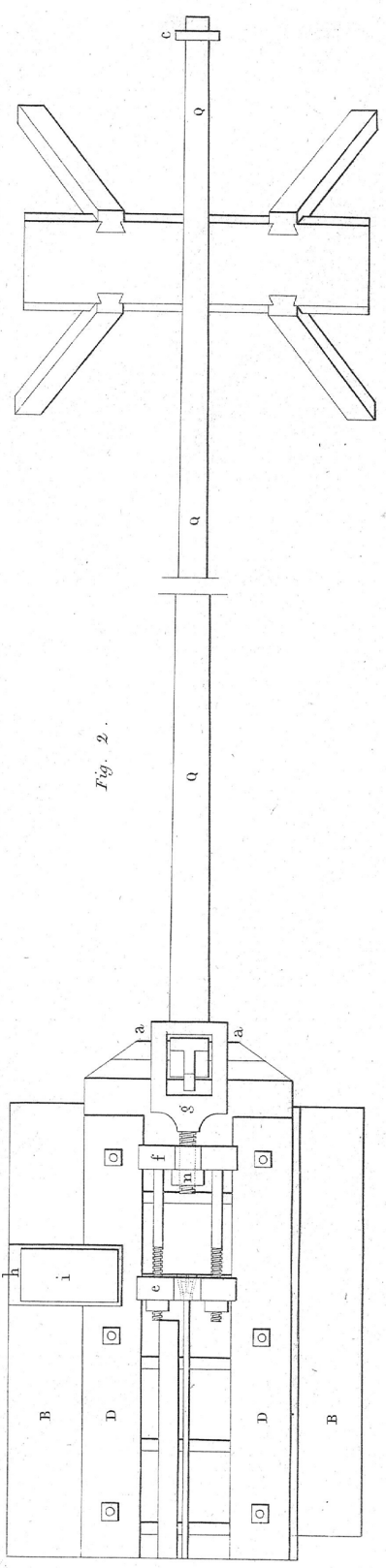
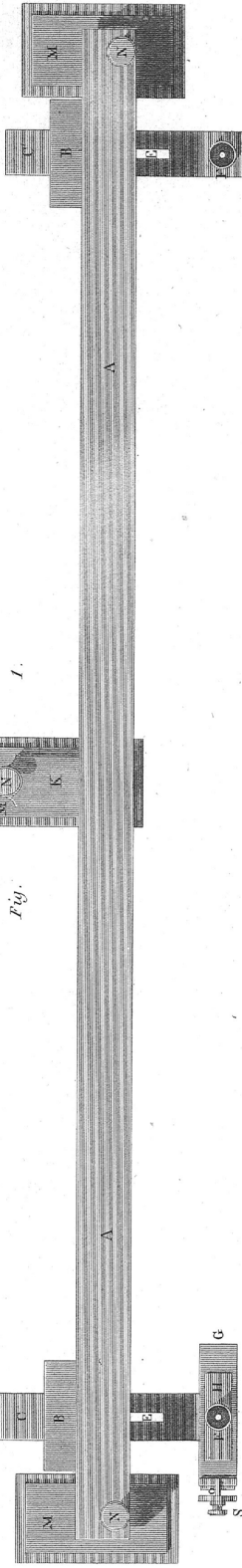
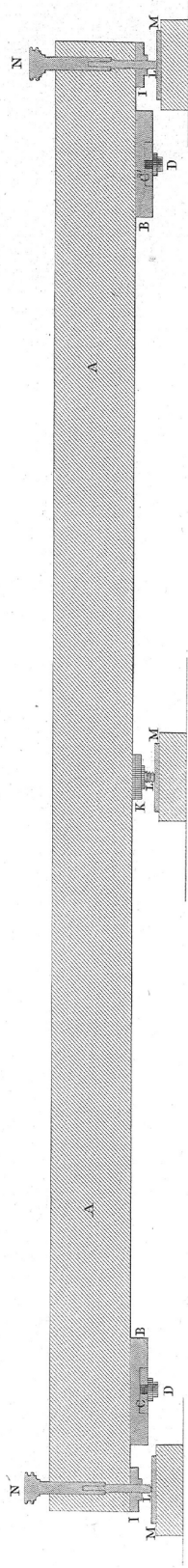

Fig. 2.

C. J. Downing, Jr.

Tab. IV.

Fig. 2



I.

Fig.

1.	2.	3.	4.	5.	6.	7.	8.	9.	10.

Aluar.

Tab. V.

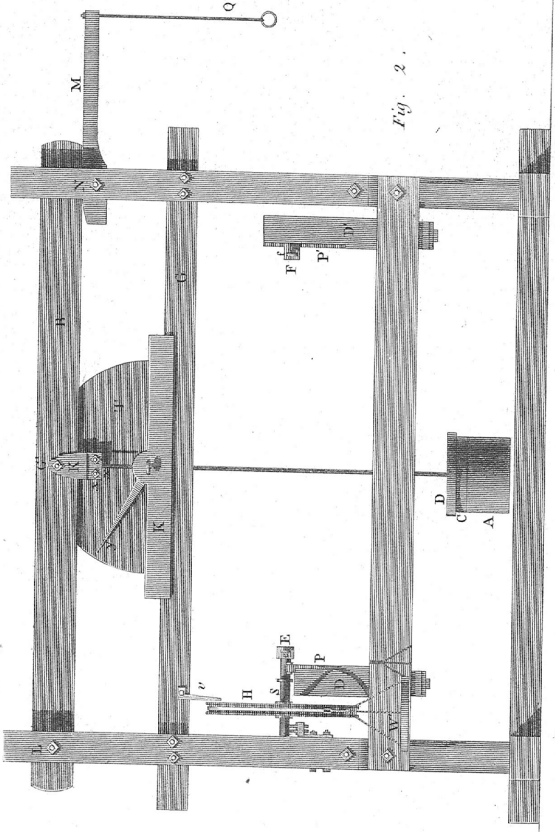

Fig. 2.

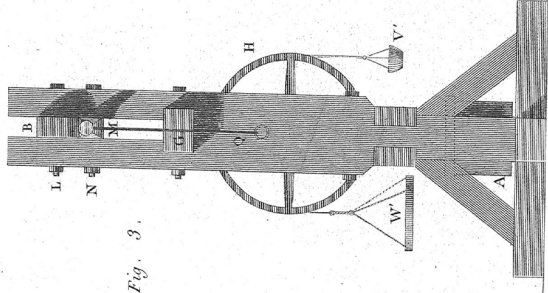

Fig. 3.

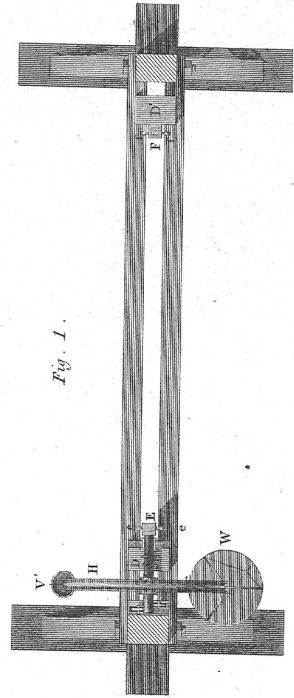
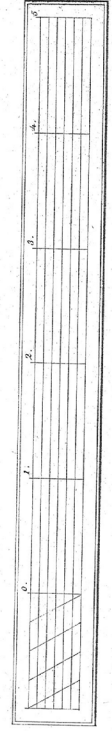

Fig. 1.



Abstr.

Fig. 1.

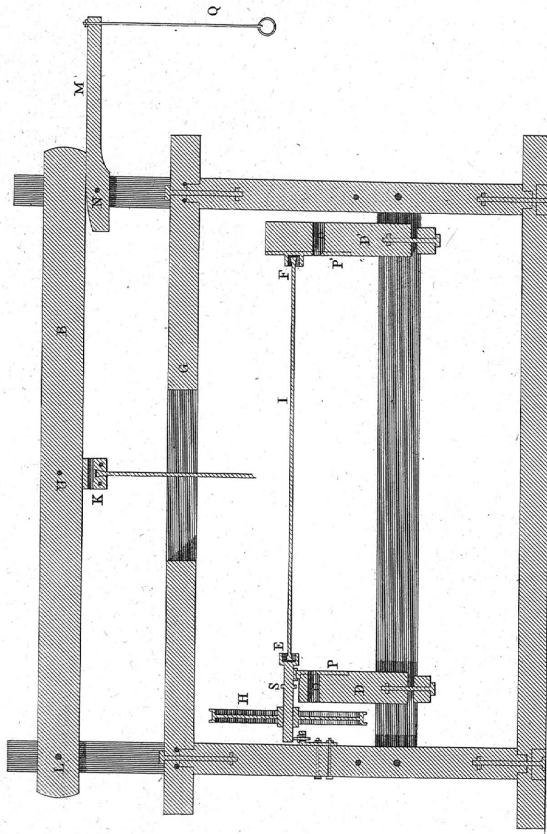

Fig. 2.

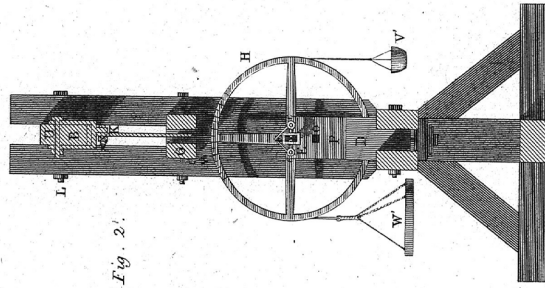
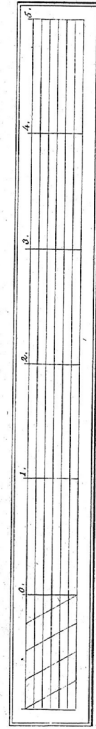
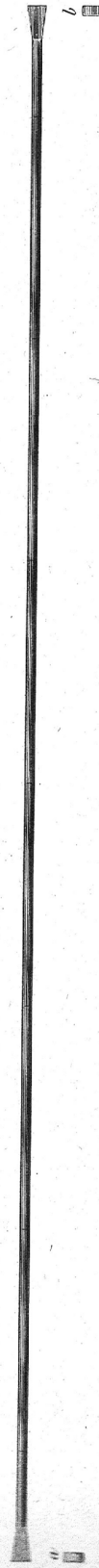

Fig. 3.



Albar.



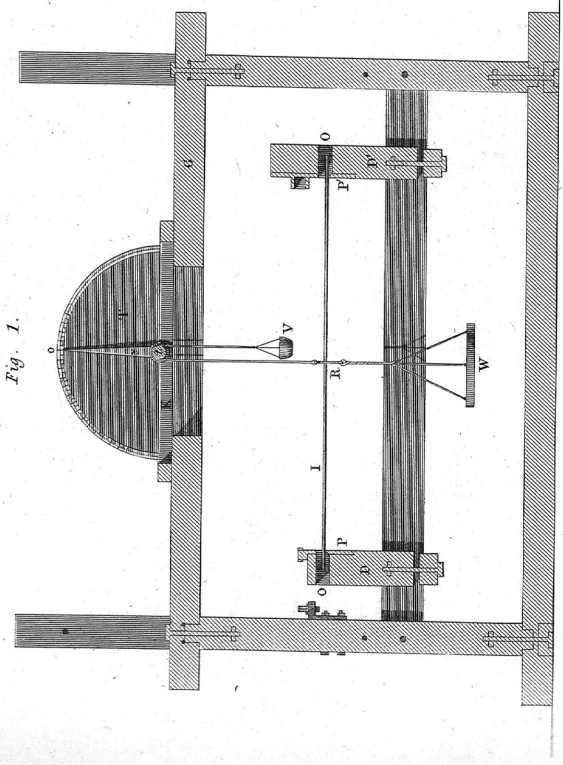

Fig. 1.

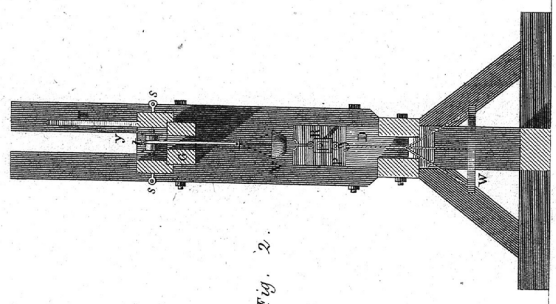
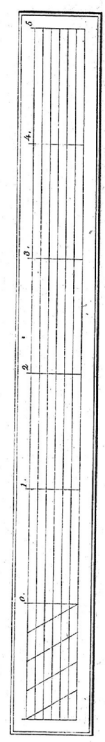
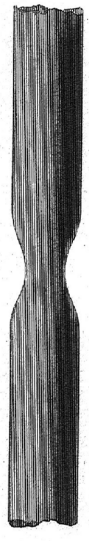

Fig. 2.

Fig. 3.



Aluar.

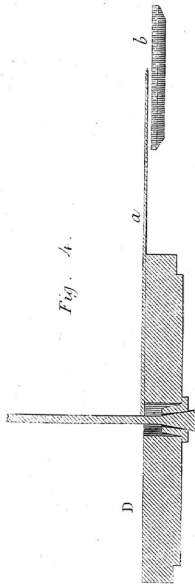
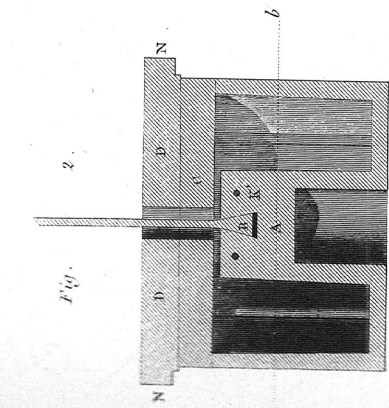

Fig. 1.

Fig. 2.

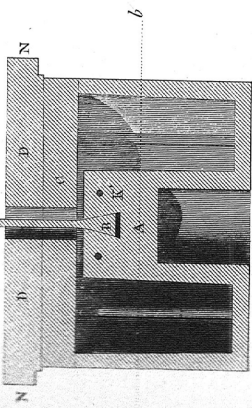

Fig. 3.

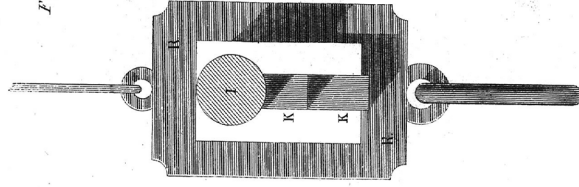

Fig. 4.

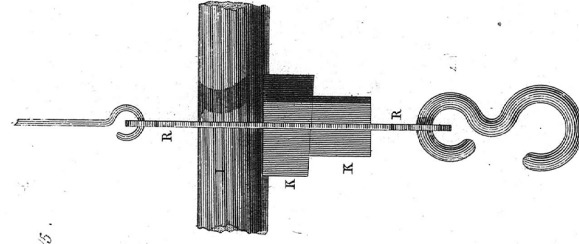
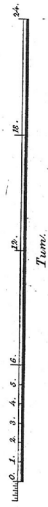
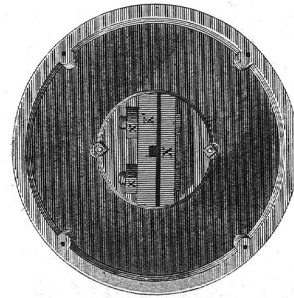

Fig. 5.

Fig. 1.



Tome.

Fig. 2.



Fig. 1.

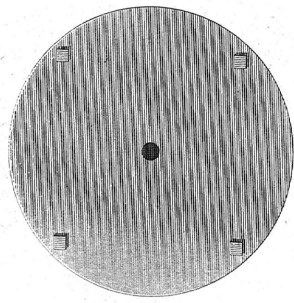

Fig.

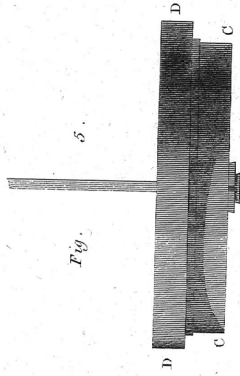

Fig.

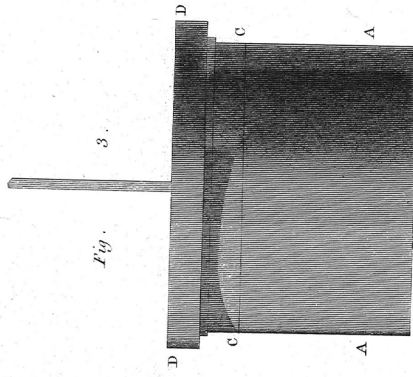

Fig.

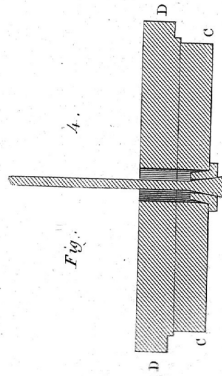

Fig. 6.

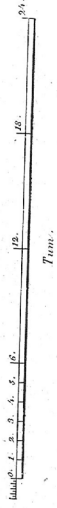
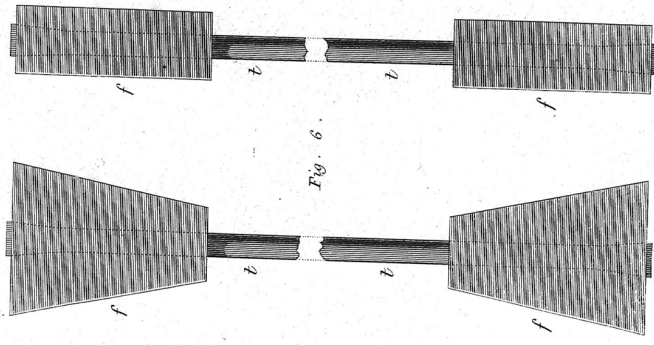

Fig. 1.

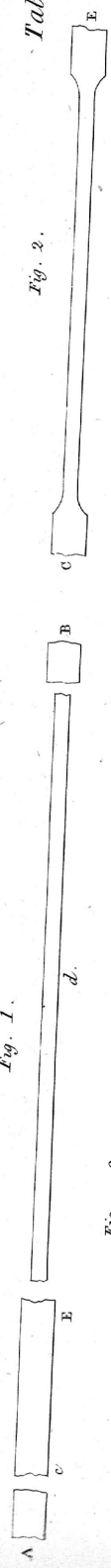

Fig. 2.

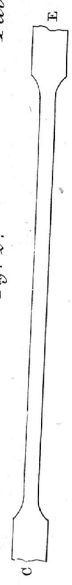

Fig. 3.



Fig. 4.



Fig. 5.

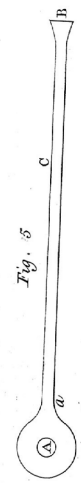

Fig. 6.

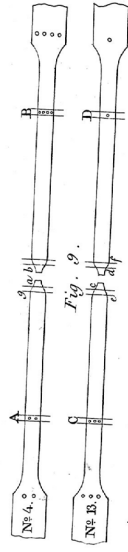

Fig. 7.

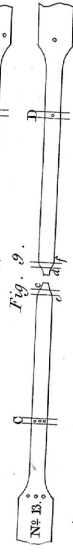

Fig. 8.

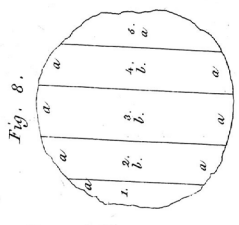

Fig. 9.



Fig. 10.

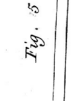

Fig. 11.



Fig. 12.



Fig. 13.



Fig. 14.



Fig. 15.



Fig. 16.

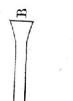

Fig. 17.



Fig. 18.



Fig. 19.



Fig. 20.



Fig. 21.



Fig. 22.

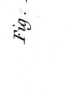

Fig. 23.



Fig. 24.



Fig. 25.



Fig. 26.

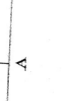

Fig. 27.

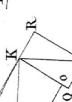

Fig. 28.



Fig. 29.



Fig. 30.



Fig. 31.

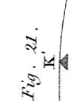

Fig. 32.

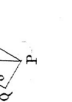

Fig. 33.



Fig. 34.



Fig. 35.



Fig. 36.

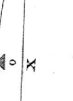

Fig. 37.



Fig. 38.



Fig. 39.



Fig. 40.



Fig. 41.

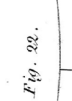

Fig. 42.



Fig. 43.

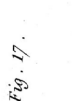

Fig. 44.



Fig. 45.



Fig. 46.

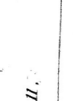

Fig. 47.



Fig. 48.

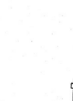

Fig. 49.



Fig. 50.

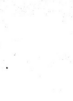

Fig. 51.



Fig. 52.

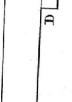

Fig. 53.

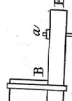

Fig. 54.



Fig. 55.



Fig. 56.



Fig. 57.

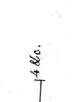

Fig. 58.

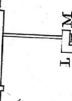

Fig. 59.

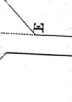
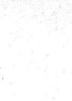
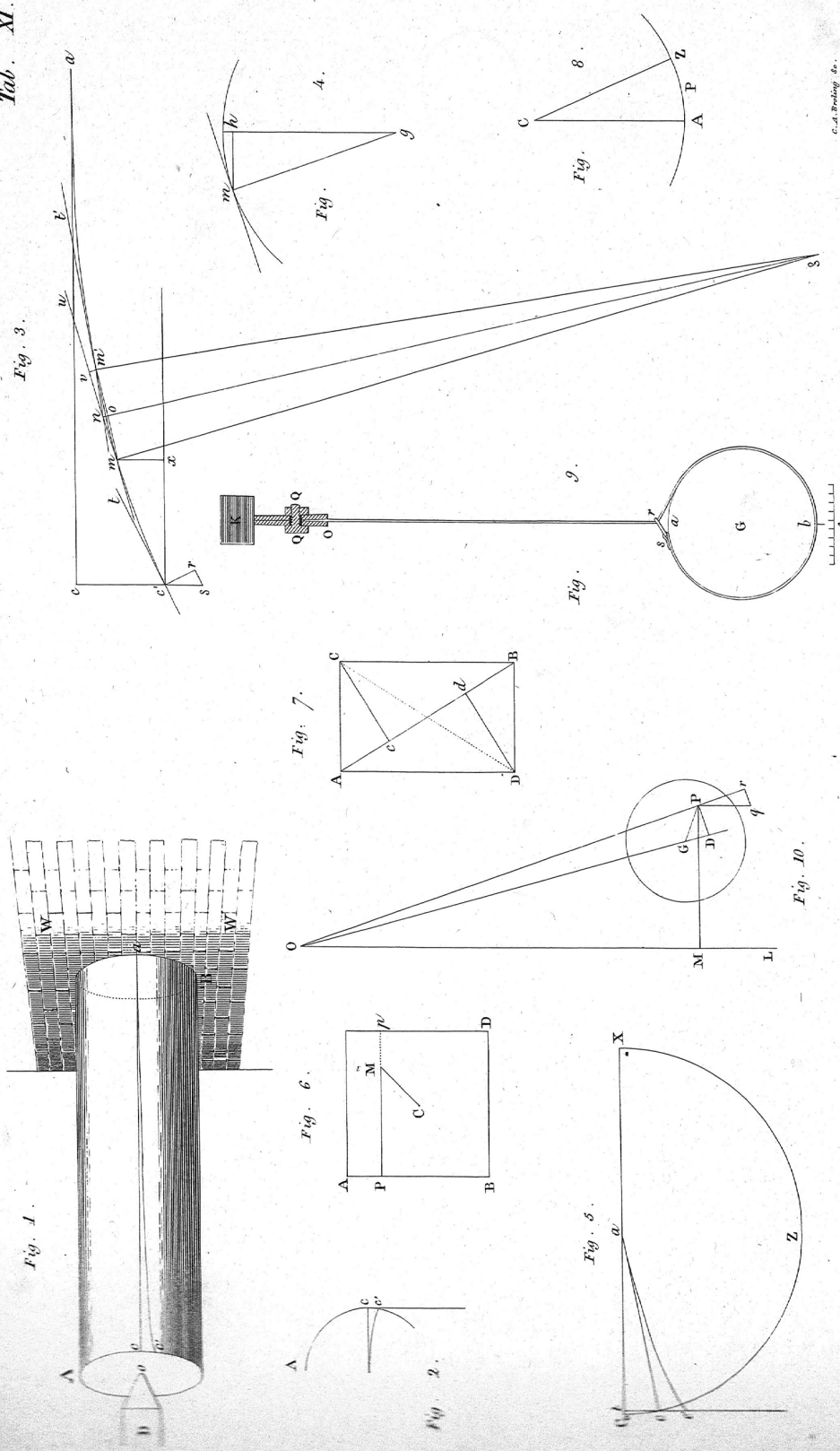

Fig. 60.



Tab. XI.



C. A. Bunting & Co.